



QUICK TOUCH TIMER CONTROL

(PACKAGED INSIDE ELECTRICAL BOX)



CR-9 OR CR-11 STEAM GENERATOR



CONTROL CORD SET



WATER INLET

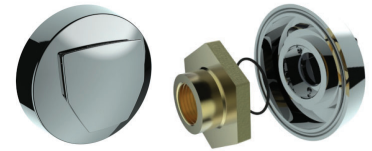

ONE 3/4" STEAM DIFFUSER

USE ONLY RELAX-A-MIST® FACTORY SUPPLIED PARTS

1. GENERAL INFORMATION (See Steam Generator Selection)
STEAM GENERATOR LOCATION

The steam generator should be located in a ventilated area outside of, but within 20 feet of the shower or steam room, where the steam pipe can be installed without the possibility of a steam trap. The steam generator may be placed under the floor, in a closet, or any convenient location where it WILL BE LEVEL, DRY, AND WILL NOT FREEZE in the winter. The steam generator MUST be easily accessible should service be required in the future. INSTALL THE STEAM GENERATOR WITH THE COPPER STEAM PIPE COMING OUT OF THE TOP OF THE APPLIANCE AND THE ELECTRICAL BOX FACING THE ACCESS! See Fig. 1.

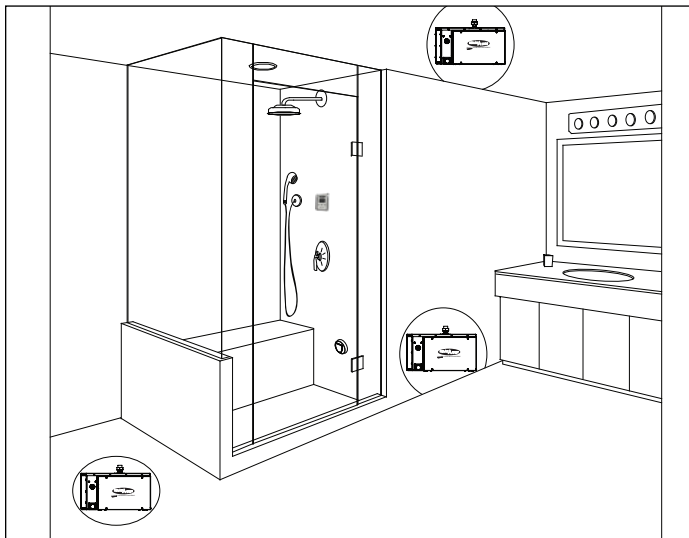

Fig. 1

STEAM PIPING AND STEAM DIFFUSER

(To and in the steam room) (Max. steam line: 25 ft.)

The steam pipe must be a minimum of 3/4 inch I.D. rigid copper. Installing the steam pipe using the most direct or shortest route (WITHOUT FORMING A STEAM TRAP) and with the fewest number of elbows will, in most cases, maintain a lower pressure (less than 1 lb) in the boiling tank than a longer route with many elbows. The Relax-A-Mist® steam diffuser uses standard construction

materials, tools and methods. Depending on wall thickness, a custom sized nipple may need to be fabricated by the plumber or purchased from a local hardware store. **It is important to install the steam diffuser in an area where a person cannot be burned from the hot steam exiting the diffuser.** The steam diffuser was designed to be installed on a flat surface. During the final installation, the steam diffuser supplied MUST be used. See **Steam Piping to Bath or Shower, CAUTION 1-3, and Fig. 2.**

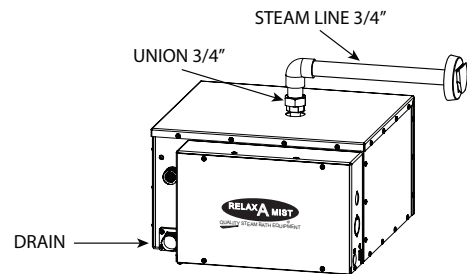

Fig. 2

CAUTION: There is to be **NO RESTRICTION** in the STEAM PIPE BETWEEN the STEAM GENERATOR and the STEAM DIFFUSER that would in any way cause PRESSURE to build in the STEAM GENERATOR. Do not pressurize steam generator or use steam generator to pressure test steam line piping. **INSTALL the STEAM DIFFUSER 12 INCHES above the finished floor, in a LOCATION where the STEAM WILL NOT BURN anyone.**

TIMER SWITCH (Steam Generator Control)

The Quick Touch Timer can be located inside or outside the steam room. If using the optional Time and Temperature Control, refer to that control's installation instructions now. Relax-A-Mist® timer switches are not precision timing devices. See **CAUTION 11.**

DRAIN VALVE OPTION (Ask Dealer For Details)

A 3/4 inch copper, female adapter (located below the water supply connection), can be plumbed to a drain with either a manual shut-off or an automatic drain valve installed at the steam generator (purchased separately). See **Fig. 2.**

2. ROUGH-IN

WATER SUPPLY (According to Local Plumbing Code)

The water supply pipe should be equipped with a shut-off that is accessible and close to the steam generator. Installation of a water hammer arrester (water bumper) is recommended. To maintain a proper water level in the generator, the water supply should have a minimum of 20 lbs pressure. If the water supply contains impurities that could cause scale build-up or corrode the steam generator, install appropriate water treatment. See **CAUTION 4** and **Warranty Policy**. See diagrams on **Page 6**.

DRAIN VALVE OPTION (According to Local Plumbing Code)

A 3/4 inch rigid copper pipe must be installed from the steam generator location to a drain. Ensure that all water is able to drain from all sections of the drain line at all times. Ask dealer for automatic drain details.

ELECTRICAL - WATTS, WIRE AND FUSE SIZES

(According to Local Electrical Code - Use Copper Wire Only - Must be Installed by a Qualified Electrician)

Check to ensure that the supply voltage (either 208V or 240V) is compatible with the voltage listed on the steam generator identification label (below water supply). The fuses or circuit breaker must be of adequate size to carry the necessary amperage to operate the steam generator.

STEAM GENERATOR:	CR-9	CR-11
WATTS	9,000	10,500
Hz	60	60
Phase	1	1
208 VOLTS		
Fuse/Breaker Size	60 Amp	70 Amp
Copper Wire - Supply	#6 AWG	#4 AWG
Copper Wire - Switch	#22 AWG	#22 AWG
240 VOLTS		
Fuse/Breaker Size	50 Amp	60 Amp
Copper Wire - Supply	#8 AWG	#6 AWG
Copper Wire - Switch	#22 AWG	#22 AWG
* Must use supply wires suitable for 90°C		
* Wire size may differ depending on temperature rating; consult with certified Electrician.		

Select a convenient location in the steam room, within 20 feet of the steam generator (5 feet up from the finished floor, **away from the area above the steam diffuser**), to install the Quick Touch Timer (found in the appliance electrical box), and cord set packaged with steam unit. Cut a 7/8 inch hole in the wall material and pass the female end of the cord set through the wall for final installation **OR**, the Time and Temperature Control with remote may be installed (**purchased separately**). **ASK DEALER FOR DETAILS.**

There is one class 1, 2 conductor copper wire and ground power cable, and one, factory supplied, class 2 25 foot control wire to be run to the steam generator:

- a) Run a copper power supply cable, 2 wire and ground, of adequate gauge to carry the necessary amperage from the fuse or circuit

- b) Run the factory supplied 25 foot cord set from the steam generator location to the Timer Control location. Leave sufficient length at each end of cord set for the final installation connections. See **CAUTION 8-10**.

THE ELECTRICAL “**SUPPLY**” FOR THE STEAM GENERATOR **CANNOT** BE SWITCHED DIRECTLY BY THE TIMER CONTROL SUPPLIED WITH THE STEAM GENERATOR. **Use Copper Supply Wire Only.** The copper power supply cable must run directly from the fuse or circuit breaker to the steam generator. The factory supplied cord set must be run directly from the steam generator to the Timer Control. The Timer Control activates a contactor in the steam generator, through the class 2 voltage circuitry.

STEAM PIPING TO BATH OR SHOWER

The steam pipe must be a minimum of 3/4 inch I.D. type “L” or “M” rigid copper. Install rigid copper pipe (**maximum length of 25 feet**), from the steam generator to where it will enter the steam bath area, in a location where the steam will not burn anyone. Insulate the steam pipe for maximum efficiency. **WARNING: STEAM DIFFUSER IS HOT AND CAN CAUSE SEVERE BURNS. LIVE STEAM IS 212 °F (100 °C).**

The 3/4” end of the steam pipe at the steam room should have a female pipe thread fitting that is attached to something solid, (example: a “wing-back 90 elbow”). **IMPORTANT - Ensure the elbow is perpendicular to the finished wall on two axis. Check its orientation by threading in a nipple that extends past the studs and out beyond the finished wall.** This way during the final installation of the steam diffuser, it will be square to the finished wall. Be sure the wing-back 90 elbow backing can withstand the force of tightening the nipple and steam diffuser to the correct torque required to prevent leaks. For steam diffuser location purposes during rough-in, install a 3/4 inch iron pipe nipple into the female fitting, hand tight, between 2 and 2-1/2 turns (the final tightening will be 4 turns), so it will protrude through the wall into the steam room. After the finished walls are in place, the iron nipple will be replaced by a brass nipple of the appropriate length. See **Final Installation Steam Piping** and **Fig. 3**.

- 1 - Steam diffuser
- 2 - O-ring
- 3 - 3/4” C x FIP adapter
- 4 - Sealer (silicone)
- 5 - Finished wall
- 6 - 3/4” brass nipple
- 7 - 3/4” C x C wing-back elbow
- 8 - 3/4” copper pipe type “L”
- 9 - 12” from steam pipe to steam room floor.

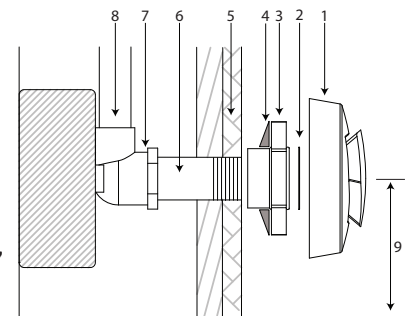

Fig. 3

WARNING: STEAM DIFFUSERS ARE HOT AND CAN CAUSE SEVERE BURNS.

In a shower or steam room, the centre of the brass nipples

and steam diffusers must be 12 inches above the finished floor and in a location away from the user's pathways, where the steam will not burn anyone, preferably on the same wall as the shower controls. See Fig. 1.

If the steam diffuser is installed too low or too close to a corner, the steam will strike the floor or wall (may cause damage to tile grout) and condense into water before it can heat and steam the room. Installing the steam diffuser correctly, in the lower part of the room, ensures a more even distribution of the heat and steam. **It is not recommended to place the steam diffuser under a bench, as there is a distinct possibility that someone sitting on the bench could inadvertently put their feet underneath it and be burned.** When the steam diffuser is installed under a bench, it is sometimes impossible for the heat and steam to circulate throughout the room.

Care MUST be taken to AVOID A STEAM TRAP! Water must be able to drain from all sections of the steam pipe at all times. See CAUTIONS 1-2 and Fig. 4.

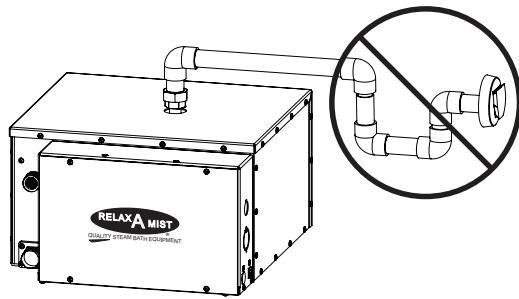

Fig. 4

3. FINAL INSTALLATION

WATER SUPPLY (According to Local Plumbing Code)

The water inlet connection on the steam generator is a male garden thread. A swivel garden hose to 3/8 inch tubing adapter is supplied for the installer's connection. The swivel adapter will be a union. Install a shut-off on the water supply and reduce it to use 3/8 inch O.D. soft copper tubing. Use 3/8 inch O.D. soft copper tubing between the shut-off and the swivel adapter at the steam generator. Form a "loop" in the 3/8 inch soft copper tubing to ensure the boiler is being installed level. See Fig. 5.

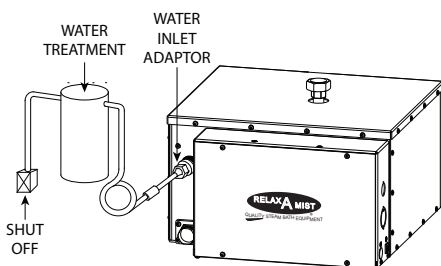

Fig. 5

DRAIN VALVE OPTION (According to Local Plumbing Code)

Install the shut-off (purchased separately), within 1 foot of the steam unit, between the 3/4 inch copper female adapter and a 3/4 inch union attached to the drain line. Drain valve must be closed when steam unit is in operation. For the automatic drain option, ask your Dealer for details.

ELECTRICAL (According to Local Electrical Code)

Check to ensure that the supply voltage (either 208V or 240V) is compatible with the voltage listed on the steam generator identification label (below the water supply). Pull the roughed-in copper supply cable (2 wires and ground) into the steam generator electrical connection box using the knock-outs; DO NOT drill holes in the electrical box. Proceed with "a & b". Move the control cord set to the outside right of the electrical connection box and proceed with "c & d".

- a) Connect the copper power supply ground wire to the Relax-A-Mist® grounding lug inside the appliance's electrical connection box; use provided knockouts.
- b) Connect the two copper wires from the power supply, one to each of the red and black Relax-A-Mist® wires inside the electrical box. See Fig. 6.
- c) On the side panel of the steam generator electrical box, remove the protective label marked "Remove To Insert Modular Connector", from the rear modular female plug. Front plug is for optional Automatic Drain.

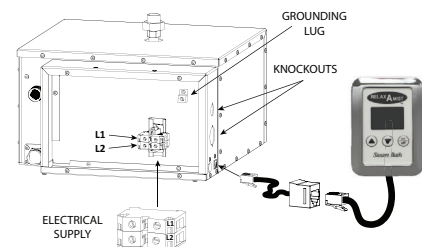

Fig. 6

Note: At this point, the control, cord set and steam generator functions must be tested. Before continuing with the final electrical installation, proceed to **Timer Pretest**. After the Timer Pretest has successfully been completed, continue to step **d)**.

- DO NOT CUT FACTORY WIRING TO INSTALL TIMER SWITCH
- DO NOT FORCE CONNECTIONS
- SEE CAUTION 6-12
- DO NOT ADHERE QUICK TOUCH TIMER TO WALL UNTIL TIMER PRETEST HAS SUCCESSFULLY BEEN COMPLETED.

TIMER PRETEST

The following instructions are for the Quick Touch Timer. If you have purchased the Time and Temperature Control with remote or an alternate control, refer to their instructions now.

- i) With the water and power supply turned on, insert the male plug from the Quick Touch Timer wire directly into the steam generator female connector so the retaining tab locks in place with an audible "click". See electrical diagram on **Page 7**. The timer display will illuminate two horizontal bars, indicating the timer is connected and has power. If the timer display does not illuminate horizontal bars, check all electrical connections and correct. If problem persists, call 1-800-Y-U-STEAM (1-800-987-8326) Monday to Friday, 8:00am to 4:30pm PST or e-mail technicalsupport@relax-a-mist.com for assistance.

- ii) When the display illuminates the horizontal bars, press the "on/off" button; the display will show 30 minutes. Listen to hear the generator filling with water and the audible "click" of the contactor closing. When the water valve finishes filling the unit, arrow the timer control down to zero. When zero is reached, the horizontal bars will reappear and the steam unit will turn off.
- iii) Remove the plastic cover from the timer cord set and insert the male plug, retaining tab to bottom, into the female plug on the steam generator. At the timer control location, remove the protective label from the female connector on the cord set. Insert the male plug from the Quick Touch Timer wire into the female connector. When the display illuminates the horizontal bars, press the "on/off" button; the display will show 30 minutes. When steam enters the room, arrow the timer control down to zero. When zero is reached, the horizontal bars will reappear and the steam unit will turn off.
- iv) This successfully completes the **Timer Pretest**; turn off the water and power supply and proceed to step d).
- d) If the **Timer Pretest** has been successfully completed, the Timer Control may now be applied to a clean, flat, dry, finished surface. Peel off the protective film from the back of the timer. Push the excess cord into the wall cavity. Firmly press the Quick Touch Timer onto the wall. If the wall surface is uneven, apply a silicone sealant to seal around the timer switch. Continue to **Steam Piping**.

STEAM PIPING

THE STEAM GENERATOR MUST BE POSITIONED WITH THE STEAM PIPE COMING OUT OF THE TOP OF THE UNIT. Using the 3/4 inch union provided and 2 wrenches, connect the roughed-in steam pipe to the generator steam pipe.

Where the 3/4 inch iron pipe nipple sticks out from the finished wall in the shower, make a mark on the iron nipple that is flush with the finished wall. Remove the iron nipple and add an additional 3/16 inch (0.1875 inches) to allow for the final tightening of the brass nipple, four turns into the wing-back

elbow, past your original mark. This is the length of brass nipple required to install the steam diffuser for your wall thickness. Once the appropriate size nipple has been selected, apply Teflon tape or thread sealant on both ends of the nipple. Use an inside nipple wrench to tighten the nipple to the wing-back elbow inside the wall (usually four turns), through a 1-3/8 inch wide hole in the tile. When installed, the brass nipple should be flush with the tile. If the brass nipple extends beyond the tile, adjust the nipple length or the steam diffuser may not be flush with the tile during the final installation. Apply silicone around the back of the brass pipe adapter to seal between the adapter and the tile. Using a 2 inch wrench, tighten the brass pipe adapter (approximately four turns), until it is tight and within 1/16 inch or less, of the finished wall. Wipe away any excess silicone that has oozed out onto the wall tile during the tightening process.

Apply a small bead of silicone in the groove around the outside edge of the backside of the steam diffuser. Lubricate the O-ring on the brass pipe adapter with water. Ensuring that the steam diffuser is parallel to the wall, push it onto the brass pipe adapter. Wipe away any excess silicone from around the steam diffuser. See **Fig. 3** and **Fig. 7**.

Note: Masking the diffuser and wall with tape may help to avoid getting excess silicone on the diffuser and tile.

In a shower or steam room where the steam lines have been roughed in according to the instructions above, the installed steam diffusers should be against the wall and there should be 12 inches from the steam diffuser opening to the finished floor.

- 1- Steam diffuser
- 2 - 3/4" C x FIP adapter
- 3 - 3/4" brass nipple
- 4 - 3/4" C x C wing-back elbow
- 5 - 3/4" copper pipe type "L"
- 6 - Finished wall
- 7 - 12" from steam pipe to steam room floor.

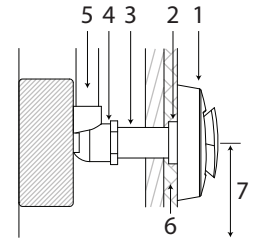

Fig. 7

CAUTION CAUTION CAUTION

- 1. a. Under NO circumstances is the steam line from the steam generator to be restricted or reduced to less than 1/2 inch inside diameter, or contain a steam trap. **Recommended steam line distance: maximum 25 feet.**
- b. Under NO circumstance is there to be a valve or other obstruction in the steam line.
- 2. Water MUST be able to drain from ALL sections of the steam line at all times.
- 3. Use only the steam diffuser that is supplied with the steam generator. For safety reasons, it MUST be used.
- 4. Adequately treat impure water or the Warranty may become null and void.
- 5. The steam generator MUST be positioned so that THE STEAM LINE COMES OUT OF THE TOP OF THE APPLIANCE.
- 6. Use only the factory modular cord set supplied with appliance. Any substitute connector or cord set may damage or will not operate the appliance and will void the Warranty.
- 7. Cutting or tampering with the internal wiring or cord sets will void the Warranty.
- 8. **DO NOT** install the Timer Control above the steam diffuser. Place away from area above the steam diffuser.
- 9. **DO NOT** pull on the cord set plugs during installation.
- 10. Check orientation of female and male low voltage connectors to ensure parts are inserted in the correct position.
- 11. **DO NOT** adhere the Timer Control to the wall until the **Timer Pretest** procedure has been **successfully completed**.
- 12. Installations are to be performed by a qualified Plumber and Electrician, in accordance with **local plumbing and electrical codes**.
- 13. Steam is hot and can cause severe burns. Be aware of the steam nozzle(s) and the hot steam exiting them.
- 14. Do not pressurize steam generator or use steam generator to pressure test steam line piping.

Relax-A-Mist® Steam Generator Start Up

The following instructions are for the Quick Touch Timer. If you have installed the Time & Temperature Control with remote or an alternate control, refer to their start up instructions now.

1. To start, make sure the electrical supply and the water supply are both in the **OFF** position. Make sure that all plumbing and electrical connections are correct. Ensure the Flow Stabilizer (supplied with JR models), has **NOT** been installed.
2. If the drain option is used with a manual shut-off, ensure it is in the closed position.
3. Turn on the water supply to the steam generator. No water will enter the unit, as the electricity is still off at this point.
4. Turn on the electrical supply to the steam generator.
5. The display on the Quick Touch Timer has two horizontal bars illuminated. Press the "on/off" button on the Quick Touch Timer. The display will read "30" minutes. This will energize the contactor coil, which will sound an audible "click" as the contacts close and will in turn energize the water level sensing device. The water entering the appliance will be audible in the form of several short "spurts" of water and will stop when the operating water level has been achieved. If the unit shuts off before water fill is complete, press the "off" ("on/off") button on the Quick Touch Timer and then press the "on" ("on/off") button again to restart the cycle to complete the filling.
Caution: The Steam Diffuser is HOT. Warning: HOT Steam will Burn You.
6. Within a few minutes from energizing the Relax-A-Mist®, steam should enter the steam room.
Scalding Caution: When the generator is first turned on, there may be an initial burst of hot water from the steam diffuser until the steam lines have come up to temperature. After the steam room has heated to a satisfactory temperature, adjust the timer display by pressing the "up" or "down" arrows to increase or decrease the length of time desired for a steam bath.
7. The installer must leave these instructions with the home owner and/or end user. Sit back, relax, and enjoy!

STEAM GENERATOR SELECTION

To select the correct size of steam generator, add the cubic footage of the shower with the appropriate adjustment to determine the calculated cubic footage:

1. Length x Width x Height = CUBIC FOOTAGE. Do not deduct for seating.
2. Add appropriate adjustment to account for heat loss through materials:

Acrylic or Fiberglass	No adjustment
Ceramic Tile, ¼" thick, or Cultured Marble.....	+ 30%
Ceramic Tile, ⅜" thick or thicker	+ 100%
Glass or Glass Block wall.....	+ 15%
Natural Stone or ½" thick material	+ 100%
Steam lines over 25 feet (insulate heavily)	+ 25%
Cast Iron Tub.....	+ 25%
Exterior walls subject to freezing.....	+ 30%
3. Select the generator that corresponds to your calculated cubic footage:

Model Number	CR-9	CR-11	CR-12	CR-14
Maximum Calculated Cubic Feet	375	460	545	630

4. Line voltage must be specified when ordering. **Units available in 240 or 208 Volts, 1 Phase. Single family dwellings usually have 240 Volts AC while condominiums usually have 208 Volts AC.**

Note: Use Copper Wire Only. Do not drill holes in electrical box, use provided knockouts.

DISCLAIMER:

The above information represents suggestions only. Each steam room is unique. Relax-A-Mist® manufactures steam generators only and therefore cannot warrant information given regarding steam room materials or construction techniques. Final selection of the steam room temperature setting and the duration of stay is at the discretion of the operators or owners.

Example
 A steam room is 6' wide x 7' long x 7.5' high with ¼" ceramic tile.

6' x 7' x 7.5' = 315 cubic feet
 + 30% (for ¼" thick ceramic tiles)
 = **409.5 calculated cubic feet**

For a room this size, we would recommend our model **CR-11** for rooms up to 460 calculated cubic feet.



DIAGRAM SHEET CR-9 & CR-11 1Ph - PLUMBING



WATER SUPPLY

HOSE CONNECTION FOR WATER SUPPLY
(FACTORY SUPPLIED)

DO NOT INSTALL FLOW STABILIZER

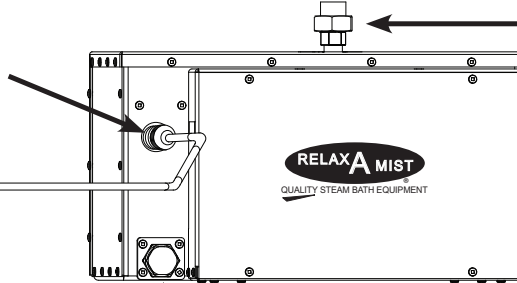
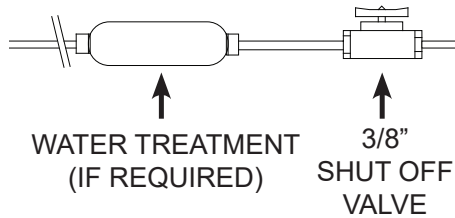

ONE 3/4" STEAM PIPE

CAUTION: DO NOT REMOVE DRAIN PLUG WITHOUT INSTALLING SHUT OFF VALVE.

OPTIONAL DRAIN FEATURES

MANUAL DRAIN VALVE (SEE YOUR DEALER)

REQUIRED PARTS
TO INSTALL MANUAL
DRAIN VALVE:

- 3/4" MALE ADAPTOR
- 3/4" COPPER PIPE
- 3/4" BALL VALVE

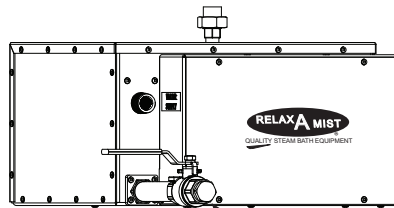

PLUMB TO DRAIN

CAUTION: DRAIN VALVE MUST BE CLOSED WHEN UNIT IS IN OPERATION

ELECTRONIC DRAIN VALVE (SEE YOUR DEALER)

REQUIRED PARTS
TO INSTALL
ELECTRONIC
DRAIN VALVE:

- 3/4" ELECTRONIC
DRAIN VALVE
(FACTORY
SUPPLIED OR
ORDERED)

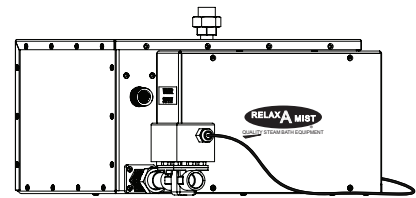

PLUMB TO DRAIN

STEAM LINE PIPING & STEAM DIFFUSER

- 3/4" COPPER PIPE, TYPE "L"
- SLOPE PIPE TOWARD
STEAM GENERATOR

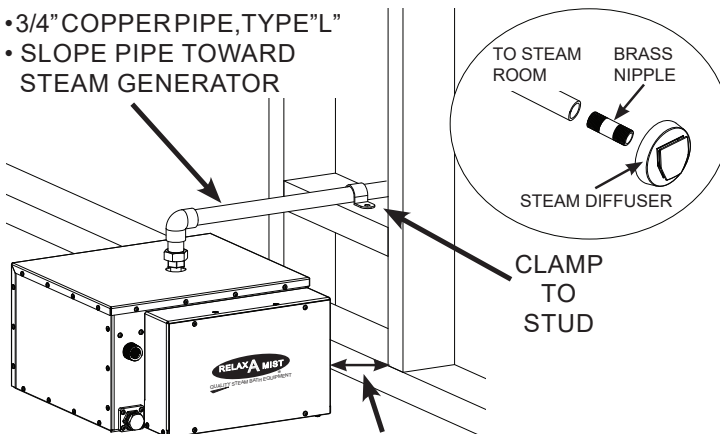

* MINIMUM 6 INCH CLEARANCE FOR MODULAR CONNECTION PLUGS

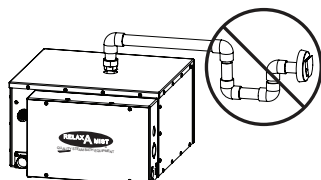

CAUTION:
DO NOT
CREATE A
STEAM TRAP!

TYPICAL STEAM DIFFUSER INSTALLATION

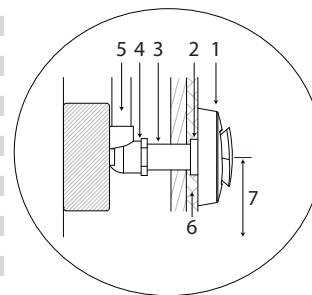

- 1- STEAM DIFFUSER
- 2 - 3/4" C X FIP ADAPTER
- 3 - 3/4" BRASS NIPPLE
- 4 - 3/4" C X C WING-BACK ELBOW
- 5 - 3/4" COPPER PIPE TYPE "L"
- 6 - FINISHED WALL
- 7 - 12" FROM STEAM PIPE TO STEAM ROOM FLOOR

- 12" FROM FINISHED FLOOR
- 12" FROM FINISHED SIDE WALL
- STEAM ROOM LAYOUT WILL DETERMINE THE STEAM DIFFUSER LOCATION

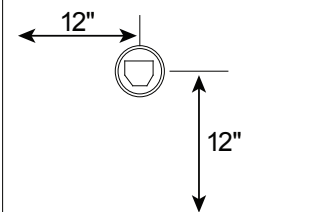

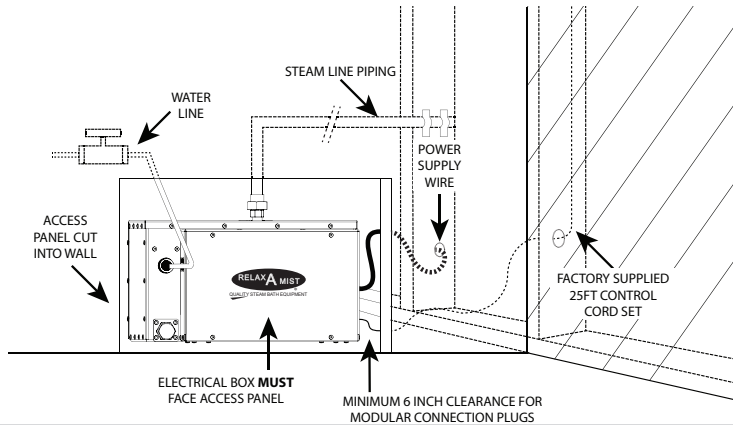

DIAGRAM SHEET CR-9 & CR-11 1Ph - ELECTRICAL



POWER SUPPLY 240/208V 1Ph

ELECTRICAL BOX MUST BE ACCESSIBLE



- CONNECT GROUND WIRE TO GROUNDING LUG
- CONNECT ELECTRICAL POWER SUPPLY WIRES TO "L1" AND "L2" TERMINALS IN ELECTRICAL BOX STEAM GENERATOR

NOTE: POLARITY MUST BE MAINTAINED WHEN CONNECTING MULTIPLE UNITS

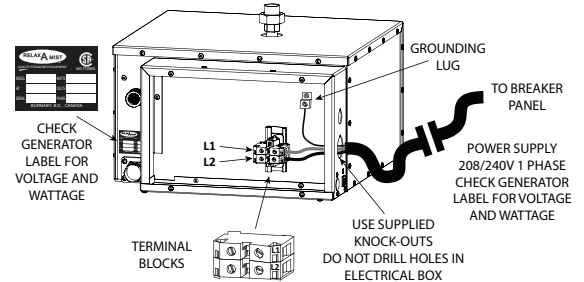

MODULAR CONNECTORS

QUICK TOUCH TIMER CONTROL

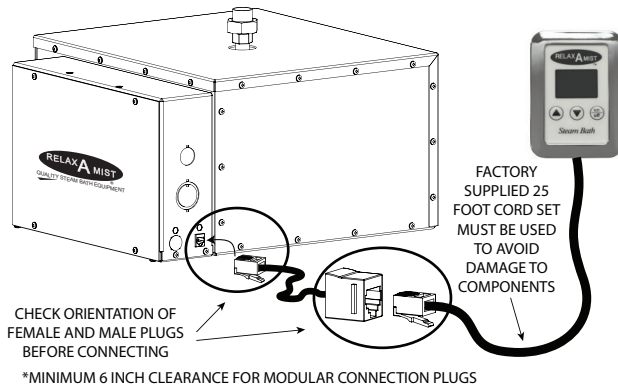

MODULAR CONNECTOR

CAUTION: INSERT FACTORY SUPPLIED CORD SET INTO RECEPTACLE MARKED "TIMER SWITCH 24VAC". GENERATOR CANNOT BE STARTED WITHOUT MODULAR CONNECTOR.

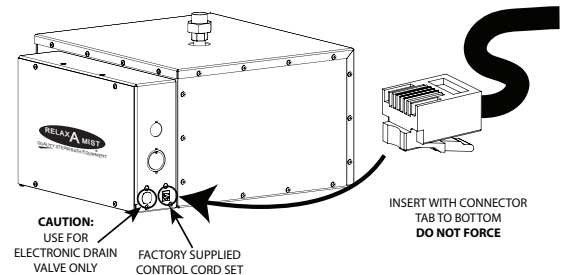

*MINIMUM 6 INCH CLEARANCE FOR MODULAR CONNECTION PLUGS

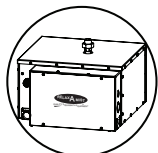

CORRECT

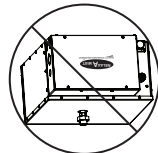

WRONG

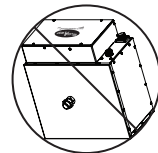

WRONG

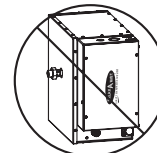

WRONG

THIS CARTON CONTAINS:

- 1 - STEAM GENERATOR
- 1 - HOSE CONNECTION (FOR WATER SUPPLY)
- 1 - 3/4" STEAM DIFFUSER
- 1 - CONTROL SWITCH
- 1 - CONTROL CORD SET (25FT)
- 1 - INSTALLATION INSTRUCTIONS
- 1 - DIAGRAM SHEET

CAUTION INSTALLER!

WARRANTY MAY BE VOID IF:

- WIRES CUT
- FUSES ON PCB ARE BURNT
- GENERATOR IS INSTALLED IN INCORRECT POSITION
- ELECTRICITY TO UNIT TURNED ON WITHOUT WATER SUPPLIED
- STEAM GENERATOR IS PRESSURIZED OR USED TO PRESSURE TEST STEAM LINE PIPING
- HOLES DRILLED INTO ELECTRICAL BOX
- FACTORY SUPPLIED MODULAR CORD SET NOT USED
- INSTALLER FAILS TO FOLLOW ANY OF THE RELAX-A-MIST® INSTALLATION INSTRUCTIONS



WARRANTY POLICY

For a period of one year from the date of installation, or 18 months from the date of manufacture, whichever comes first, all parts and assemblies are warranted as to workmanship and materials used in their manufacture. There is no cosmetic warranty on installed parts or controls. Any Relax-A-Mist® products containing defective parts, if returned prepaid to an authorized Service Depot within the one year or 18 month time limit, will be repaired free of charge, F.O.B. the authorized Service Depot making such repairs.

The Company will not be responsible for any breakdown, damage, or losses, direct or indirect, arising in contract or in tort from any cause whatsoever, including failure to follow the Relax-A-Mist® installation instructions specifically, careless handling, improper voltage supply, corrosion and/or electrolysis or a buildup of minerals on the parts or assemblies for any reason or from any source; nor for transportation and/or other charges incurred in the removal, replacement or repair of defective products or parts; and there are no warranties or conditions expressed or implied or otherwise applicable, to the company's products except as expressly stated herein.

**WARRANTY IS VOID IF RESIDENTIAL STEAM GENERATORS
ARE USED IN A COMMERCIAL INSTALLATION.**

AUTHORIZED SERVICE DEPOTS

BRITISH COLUMBIA

LEISURE BATHS LTD.
6909 Antrim Avenue
Burnaby, BC V5J 4M5

TEL 604-437-4717
or 1-800-Y-U-STEAM
(1-800-987-8326)
FAX 604-437-5776

MANITOBA

BALCAEN & SONS LTD.
1392 Pembina Highway
Winnipeg, MB R3T 2C1

TEL 204-475-1506
FAX 204-287-2222

ALBERTA

FRASER-BOND LTD.
9452 Almond Crescent S.E.
Calgary, AB T2J 1B6

TEL 403-253-7533
FAX 403-253-7583

ONTARIO

CERTIFIED MECHANICAL
29 Lloyd Avenue
Toronto, ON M6N 1H1

TEL 647-492-2696

QUEBEC

LES EQUIPMENT BERBOUR
1210 Av. Bisson,
Sainte-Marie, QC G6E 3T2

TEL 1 888-253-5610

For assistance, phone Relax-A-Mist® at 1-800-Y-U-STEAM (1-800-987-8326) or e-mail: technicalsupport@relax-a-mist.com

Please Note: Leisure Baths Ltd. shall not be held responsible for any errors in catalogues, brochures, or other printed material. As we are continuously improving and developing our products, we reserve the right to alter products or introduce modifications to the technical data at any time, without notice; therefore, we cannot accept legal liability for the information given, nor for any printing mistakes that may have occurred.